

Jacoflon

PTFE hoses with stainless steel braid

Jacoflon PTFE hoses with stainless steel braid

With **Jacoflon**, SERTO offers a product that satisfies the most demanding specifications in terms of resistance, flexibility and reliability. **Jacoflon** is a flexible PTFE hose with a stainless steel braid – ideal for sophisticated applications.

PTFE and stainless steel braid

The greatest advantage of PTFE is its excellent resistance to most chemicals, detergents and solvents, as well as steam and compressed air. Jacoflon combines the benefits of PTFE and stainless steel braid to provide you with versatility, high operational safety, long service life and increased pressure resistance.

Product range

The hoses are available in 5 different qualities with different types of fittings made of stainless steel 1.4571. SERTO produces according to customer specifications – just-in-time.

Application areas

Plant and equipment construction, air-conditioning equipment, food and beverage industry, laboratory and medical technology, water technology, aerospace industry, automotive industry

Features

- excellent resistance to nearly all chemicals, detergents and solvents
- UV and weather-proof, resistant to ageing
- high temperature resistance, non-flammable
- extremely low internal friction coefficient and therefore very low flow resistance
- absolutely non-toxic

Arguments in favour of Jacoflon

- high operational reliability
- long service life
- high abrasion resistance
- high strength under alternating flexural stress

Arguments in favour of SERTO

- outstanding quality products
- cost savings, all from one source
- customer-specific solutions
- reliable delivery service, prompt delivery, high delivery quality

Specifications

- material:
 - inner hose: PTFE
 - wire braid: stainless steel 1.4301
 - fittings: stainless steel 1.4571
- temperature range: -60°C to +250°C

Use our hose configurator in our online shop to easily request your assembled Jacoflon hose
>> shop.serto.com

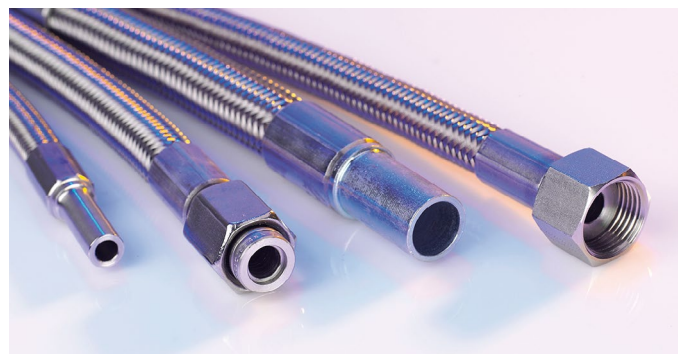
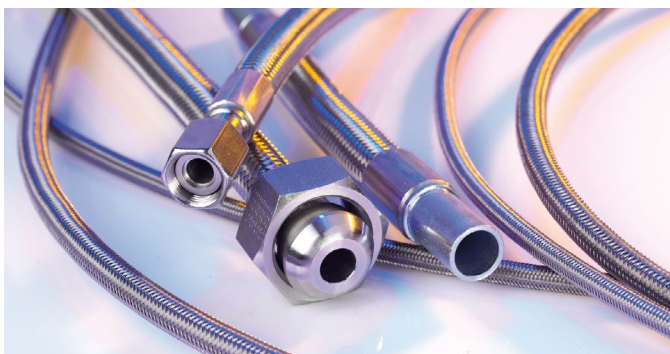

Technical data Jacoflon

Due to its flexibility and the excellent corrosion and pressure resistance the Jacoflon PTFE hose is ideally suited for special applications.

The hoses with stainless steel fittings 1.4571 are available in different lengths and designs according to customer specifications.

Connection options

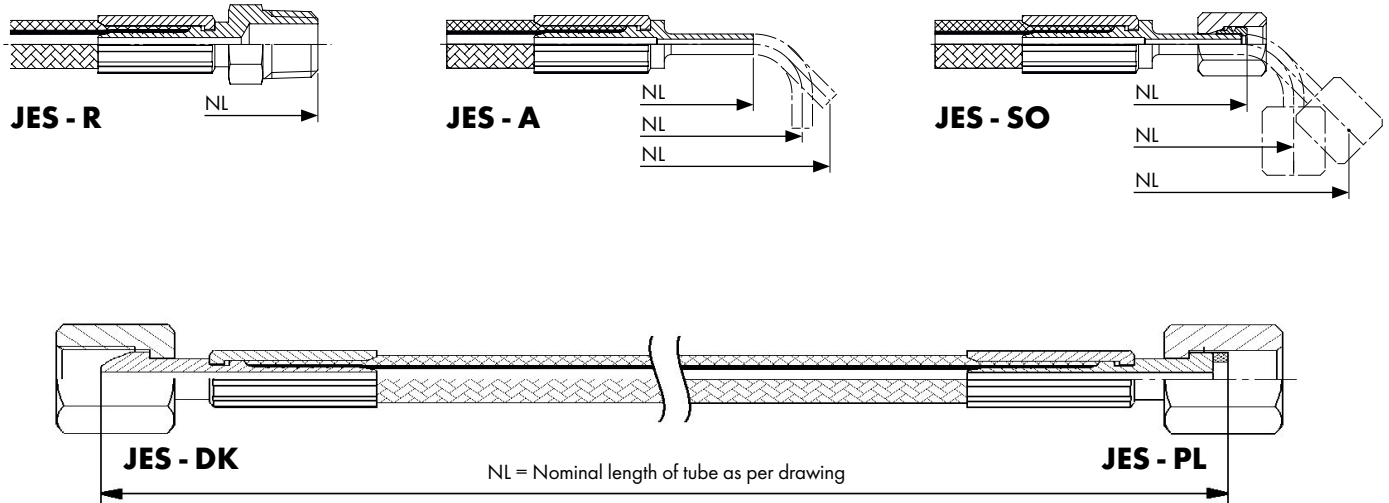

Ordering example

Example 1 AQ 1/8-R 1/8-A3x450

1 AQ 1/8-	R 1/8-	A3	x450
Type and size of the tube:	1. Fitting	2. Fitting	Tube length mm (NL)
<ul style="list-style-type: none"> • 1 AQ • 1 GQ • 1 HQ • 1 SQ • 2 SQ 	<ul style="list-style-type: none"> • Stubs with and without SERTO nut connection • Connectors with flat face end • Connectors with conical sealing • straight or angled 45°/90° 		160 mm - 20'000 mm depending on type

Tolerances for tube length mm

mm	0	500	1'000	2'000	3'000	5'000	10'000	20'000
	+5 / -3 mm	+10 / -5 mm	+20 / -10 mm	+70 / -15 mm	+80 / -20 mm	+100 / -30 mm	+150 / -40 mm	

Pressure coefficient % of PN

°C	-100°	-60°	0°	23°	60°	100°	125°	150°	175°	200°	250°	300°
			100 %	75 %	50 %	40 %	30 %	25 %	20 %	10 %		

Jacoflon Automobilqualität AQ
Jacoflon Qualité automobile AQ
Jacoflon Automobile quality AQ

JF PTFE 1 AQ

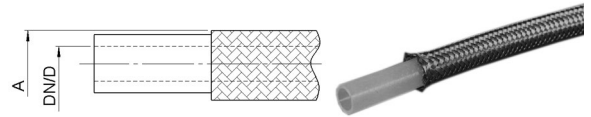

Type -DN	Mat.-Nr.	bar	D	A	B.Radius	L	kg/m
PTFE-1 AQ-1/8	490.3000.100	321	3.4	6.2	38	160.0	0.070
PTFE-1 AQ-3/16	490.3000.200	276	4.9	7.8	64	160.0	0.080

Automobile Qualität mit dickwandigem PTFE-Rohr und einfachem Drahtgeflecht (Inox 1.4301) für erhöhte Druckfestigkeit.

Qualité standard industrie automobile avec tube en PTFE à paroi épaisse et tresse en fil simple (inox 1.4301) pour résistance à la haute pression.

Automotive quality with thick-walled PTFE tube and single braid (inox 1.4301) for increased pressure resistance.

Jacoflon Gasqualität GQ
Jacoflon Qualité gaz GQ
Jacoflon Gas quality GQ

JF PTFE 1 GQ

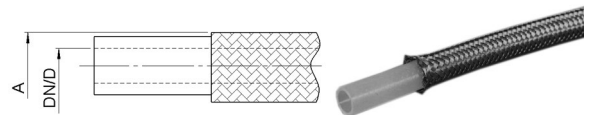

Type -DN	Mat.-Nr.	bar	D	A	B.Radius	L	kg/m
PTFE-1 GQ-1/8	490.4000.100	233	3.5	6.4	38	180.0	0.090

Gasqualität GQ mit molekularverdichtetem PTFE-Rohr und einfachem Drahtgeflecht (Inox 1.4301) - vermindert die Permeabilität für Produkte mit sehr feiner Molekularstruktur.

Qualité gaz GQ avec tube en PTFE à structure moléculaire comprimé et tresse en fil simple (inox 1.4301) - réduit la perméabilité pour produits avec structure moléculaire fine.

Gas quality GQ with molecular compressed PTFE tube and single braid (inox 1.4301) - reduces the permeability for products with very small molecular structure.

Jacoflon Hochflexible Qualität HQ
Jacoflon Qualité forte flexible HQ
Jacoflon High flexible quality HQ

JF PTFE 1 HQ

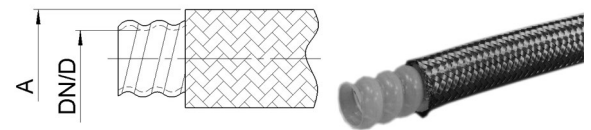

Type -DN	Mat.-Nr.	bar	D	A	B.Radius	L	kg/m
PTFE-1 HQ-3/8 GFL	490.9001.500	138	9.5	14.8	20	210.0	0.250
PTFE-1 HQ-1/2 GFL	490.9001.600	103	12.8	18.8	25	240.0	0.300
PTFE-1 HQ-3/4 GFL	490.9001.800	69	19.1	24.7	64	250.0	0.400
PTFE-1 HQ-1 GFL	490.9001.900	46	25.4	32.8	89	280.0	0.550

Hochflexible Qualität HQ, Wellenschlauch mit einfachem Drahtgeflecht (Inox 1.4301).

Qualité HQ, grande flexibilité tube convoluté avec tresse en fil simple (inox 1.4301).

High flexible quality HQ, corrugated hose with single wire jacket (inox 1.4301).

L=Mindestlänge konfektioniert
 bar=Arbeitsdruck bei 23°C
 DN/D=Rohrinnendurchmesser
 A=Rohraussendurchmesser
 B.Radius=min. Biegeradius

L=longueur min. assemblée
 bar=pression de service à 23°C
 DN/D=diamètre intérieur du tube
 A=diamètre extérieur du tube
 B.Radius=min. rayon de courbure

L=min. length assembled
 bar=operation pressure at 23°C
 DN/D=tube inside diameter
 A=tube outside diameter
 B.Radius=min. bend radius

Jacoflon Standardqualität SQ

mit einfachem Drahtgeflecht

Jacoflon Qualité standard SQ

avec tresse en fil simple

Jacoflon Standard quality SQ

with single braid

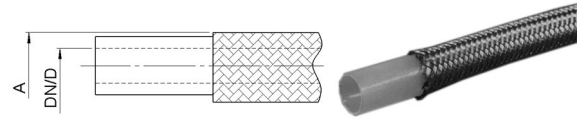
JF PTFE 1 SQ

Type -DN	Mat.-Nr.	bar	D	A	B.Radius	L	kg/m
PTFE-1 SQ DN 2,5	490.1000.010	330	2.5	4.5	25	180.0	0.100
PTFE-1 SQ-¼	490.1000.300	241	6.2	8.6	76	180.0	0.100
PTFE-1 SQ-¾	490.1000.500	219	8.9	11.7	127	190.0	0.150
PTFE-1 SQ-½	490.1000.600	161	12.3	15.4	140	215.0	0.210

Standardqualität SQ mit einfachem Drahtgeflecht (Inox 1.4301).

Qualité standard SQ avec tresse en fil simple (inox 1.4301).

Standard quality SQ with single braid (inox 1.4301).

Jacoflon Standardqualität SQ

mit zweifachem Drahtgeflecht

Jacoflon Qualité standard SQ

avec double tresse

Jacoflon Standard quality SQ

with double braid

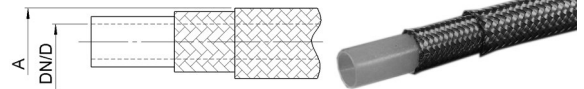
JF PTFE 2 SQ

Type -DN	Mat.-Nr.	bar	D	A	B.Radius	L	kg/m
PTFE-2 SQ-3/16	490.2000.200	299	4.9	8.9	64	160.0	0.120
PTFE-2 SQ-¼	490.2000.300	276	6.2	9.8	76	180.0	0.160
PTFE-2 SQ-¾	490.2000.500	252	8.9	13.0	127	190.0	0.260
PTFE-2 SQ-½	490.2000.600	183	12.4	16.9	140	215.0	0.350
PTFE-2 SQ-5/8	490.2000.700	172	15.2	19.7	165	210.0	0.500
PTFE-2 SQ-¾	490.2000.800	149	18.9	23.6	203	230.0	0.670
PTFE-2 SQ-1	490.2000.900	92	25.4	31.0	305	230.0	0.860

Standardqualität SQ mit zweifachem Drahtgeflecht (Inox 1.4301) für erhöhte Druck- und Biegefestigkeit.

Qualité standard SQ avec double tresse (inox 1.4301) pour une meilleure résistance à la pression et à la flexion augmentée.

Standard quality SQ with double wire jacket (inox 1.4301) for increased pressure and flexural strength.

L=Mindestlänge konfektioniert
 bar=Arbeitsdruck bei 23°C
 DN/D=Rohrinnendurchmesser
 A=Rohraussendurchmesser
 B.Radius=min. Biegeradius

L=longeur min. assemblée
 bar=pression de service à 23°C
 DN/D=diamètre intérieur du tube
 A=diamètre extérieur du tube
 B.Radius=min. rayon de courbure

L=min. length assembled
 bar=operation pressure at 23°C
 DN/D=tube inside diameter
 A=tube outside diameter
 B.Radius=min. bend radius

Rohrstutzen

für SERTO-Verschraubung

Embout lisse

pour raccords SERTO

Cylindrical stub

for SERTO unions

JES-A

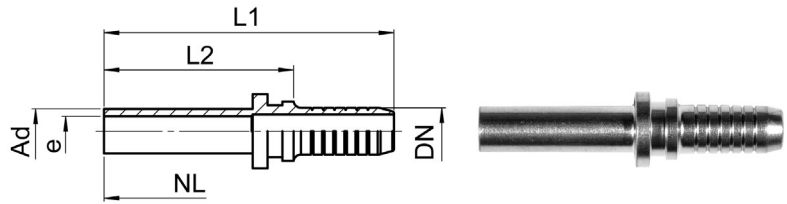

Type -DN -Ad	Mat.-Nr.	L1	L2	e	kg/100	1 AQ	1 GQ	1 HQ	1 SQ	2 SQ
JESTR DN2,5 -A3	495.1105.005	29,5	19,5	1,3	0,146				✓	
JESTR DN2,5 -A4	495.1105.012	29,5	19,5	1,3	0,190				✓	
JESTR DN2,5 -A5	495.1105.014	29,5	19,5	1,3	0,223				✓	
JESTR DN2,5 -A6	495.1105.010	29,5	19,5	1,3	0,252				✓	
JESTR 1/8 -A3	495.1105.105	32,0	18,5	1,5	0,770	✓	✓			
JESTR 1/8 -A6	495.1105.115	37,0	23,5	2,0	0,930	✓	✓			
JESTR 3/16 -A6	495.1105.215	39,0	25,5	3,0	1,010	✓				✓
JESTR 1/4 -A6	495.1105.315	39,0	25,5	4,0	1,110				✓	✓
JESTR 1/4 -A8	495.1105.319	41,0	27,5	4,5	1,270				✓	✓
JESTR 3/8 -A10	495.1105.522	46,0	29,5	7,0	1,840				✓	✓
JESTR 3/8 -A12	495.1105.525	47,0	30,5	7,0	2,380				✓	✓
JESTR 1/2 -A12	495.1105.625	50,0	30,5	9,0	3,110				✓	✓
JESTR 1/2 -A15	495.1105.635	50,0	30,5	9,5	3,630				✓	✓
JESTR 5/8 -A18	495.1105.750	58,0	35,5	12,0	6,010					✓
JESTR 3/4 -A22	495.2105.854	58,0	35,5	15,0	7,180					✓
JESTR 1 -A28	495.2105.961	74,0	51,5	21,0	14,320					✓
JESTR 3/8 -A10 HQ	495.8105.522	63,5	30,5	7,0	1,900			✓		
JESTR 3/8 -A12 HQ	495.8105.525	64,5	31,5	7,0	2,200			✓		
JESTR 1/2 -A15 HQ	495.8105.635	73,5	35,5	9,5	3,700			✓		
JESTR 3/4 -A22 HQ	495.8105.854	81,5	38,5	15,0	6,600			✓		
JESTR 1 -A28 HQ	495.8105.961	100,0	53,5	20,0	15,900			✓		

Rohrstutzen 45°

für SERTO-Verschraubung

Embout lisse 45°

pour raccords SERTO

Cylindrical stub 45°

for SERTO unions

JES-A 45°

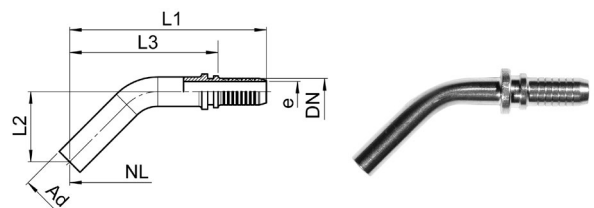

Type -DN -Ad	Mat.-Nr.	L1	L2	L3	e	kg/100	1 AQ	1 GQ	1 HQ	1 SQ	2 SQ
JESTR DN2,5-A3 45°	495.1145.005	47,0	19,0	37,0	1,5	0,733				✓	
JESTR DN2,5-A4 45°	495.1145.012	47,0	19,0	37,0	1,5	0,729				✓	
JESTR DN2,5-A5 45°	495.1145.014	47,0	19,0	37,0	1,5	0,672				✓	
JESTR DN2,5-A6 45°	495.1145.010	47,0	19,0	37,0	1,5	0,579				✓	
JESTR 1/8 -A6 45°	495.1145.115	48,5	16,0	35,0	2,0	0,600	✓	✓			
JESTR 3/16 -A6 45°	495.1145.215	48,5	16,0	35,0	2,8	0,720	✓				✓
JESTR 1/4 -A6 45°	495.1145.315	48,5	16,0	35,0	4,0	0,800				✓	✓
JESTR 1/4 -A8 45°	495.1145.319	58,0	20,0	45,0	4,5	1,480				✓	✓
JESTR 3/8 -A10 45°	495.1145.522	67,0	25,0	50,5	7,0	2,260				✓	✓
JESTR 3/8 -A12 45°	495.1145.525	76,0	29,0	59,5	7,0	3,080				✓	✓
JESTR 1/2 -A12 45°	495.1145.625	78,5	30,0	59,0	9,5	3,250				✓	✓
JESTR 1/2 -A15 45°	495.1145.635	97,0	40,0	77,0	9,5	5,540				✓	✓

NL=Nennlänge des Schlauches gemäss Massbild
DN/D=Rohrinnendurchmesser
✓=Kombinationsmöglichkeit Armatur / Schlauch

NL=longueur nominale du tuyau selon plan coté
DN/D=diamètre intérieur du tube
✓=possibilité de combinaison raccord / tuyaux

NL=nominal length of tube as per drawing
DN/D=tube inside diameter
✓=possible combinations fitting / hose

Rohrstutzen 90°

für SERTO-Verschraubung

Embout lisse 90°

pour raccords SERTO

Cylindrical stub 90°

for SERTO unions

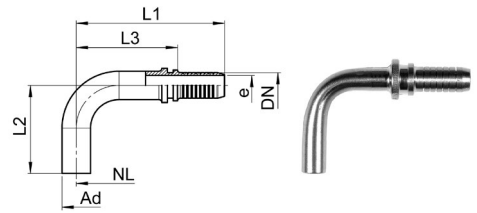

JES-A 90°

Type -DN -Ad	Mat.-Nr.	L1	L2	L3	e	kg/100	1 AQ	1 GQ	1 HQ	1 SQ	2 SQ
JESTR DN2,5 -A3 90°	495.1195.005	33.0	25.0	23.0	1.5	0.733				✓	
JESTR DN2,5 -A4 90°	495.1195.012	33.0	25.0	23.0	1.5	0.729				✓	
JESTR DN2,5 -A5 90°	495.1195.014	33.0	25.0	23.0	1.5	0.672				✓	
JESTR DN2,5 -A6 90°	495.1195.010	33.0	25.0	23.0	1.5	0.579				✓	
JESTR 1/8 -A6 90°	495.1195.115	37.0	22.0	23.5	2.0	0.600	✓	✓			
JESTR 3/16 -A6 90°	495.1195.215	37.0	22.0	23.5	2.8	0.720	✓				✓
JESTR 1/4 -A6 90°	495.1195.315	37.0	22.0	23.5	4.5	0.800				✓	✓
JESTR 1/4 -A8 90°	495.1195.319	44.0	29.0	30.5	4.5	1.480				✓	✓
JESTR 3/8 -A10 90°	495.1195.522	49.0	36.0	32.5	7.0	2.260				✓	✓
JESTR 3/8 -A12 90°	495.1195.525	57.0	39.0	40.5	7.0	3.080				✓	✓
JESTR 1/2 -A12 90°	495.1195.625	60.0	39.0	41.0	9.5	3.250				✓	✓
JESTR 1/2 -A15 90°	495.1195.635	69.5	62.0	50.0	9.5	5.540				✓	✓

Rohrstutzen

mit SERTO-Armaturenanschluss

Embout lisse

avec ecrou de raccord SERTO

Cylindrical stub

with SERTO nut connection

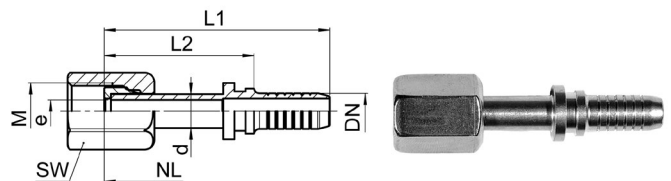

JES-SO

Type -DN -d -M	Mat.-Nr.	bar	SW	L1	L2	e	kg/100	1 AQ	1 GQ	1 HQ	1 SQ	2 SQ
JESSO DN2,5 -6 -M10x1	497.1105.010	200	12	31.0	21.0	1.3	1.100				✓	
JESSO 1/8 -3 -M6x0.75	497.1105.105	250	8	33.0	19.5	1.5	1.040	✓	✓			
JESSO 1/8 -6 -M10x1	497.1105.115	200	12	38.5	25.0	2.0	1.720	✓	✓			
JESSO 3/16 -6 -M10x1	497.1105.215	200	12	40.5	27.0	3.0	1.800	✓				✓
JESSO 1/4 -6 -M10x1	497.1105.315	200	12	40.5	27.0	4.0	1.900				✓	✓
JESSO 1/4 -8 -M12x1	497.1105.319	200	14	42.5	29.0	4.5	2.320				✓	✓
JESSO 3/8 -10 -M14x1	497.1105.522	160	17	47.5	31.0	7.0	3.620				✓	✓
JESSO 3/8 -12 -M16x1	497.1105.525	160	19	48.5	32.0	7.0	4.590				✓	✓
JESSO 1/2 -12 -M16x1	497.1105.625	160	19	51.5	32.0	9.0	5.320				✓	✓
JESSO 1/2 -15 -M20x1.5	497.1105.635	100	24	51.5	32.0	9.5	7.840				✓	✓
JESSO 5/8 -18 -M24x1.5	497.1105.750	100	30	59.5	37.0	12.0	11.060					✓
JESSO 3/4 -22 -M28x1.5	497.2105.854	64	32	59.5	37.0	15.0	15.340					✓
JESSO 1 -28 -M36x2	497.2105.961	40	41	76.0	53.5	21.0	29.320					✓
JESSO 3/8 -10 -M14x1 HQ	497.8105.522	138	17	65.0	32.0	7.0	4.200			✓		
JESSO 3/8 -12 -M16x1 HQ	497.8105.525	138	19	66.0	33.0	7.0	5.400			✓		
JESSO 1/2 -15 -M20x1.5 HQ	497.8105.635	100	24	75.0	37.0	9.5	9.100			✓		
JESSO 3/4 -22 -M28x1.5 HQ	497.8105.854	64	32	83.0	40.0	15.0	16.600			✓		
JESSO 1 -28 -M36x2 HQ	497.8105.961	40	41	102.0	55.5	20.0	34.400			✓		

Bei Kombinationen Jacoflon-Schlauch mit JES-SO Armaturen gilt die jeweils schwächere Druckangabe.

Pour des combinaisons de tuyaux Jacoflon équipés de raccords JES-SO, il faut prendre en compte la pression la plus faible des composants.

For combinations Jacoflon tube with JES-SO unions, the lower pressure value applies.

NL=Nennlänge des Schlauches gemäß Massbild
DN/D=Rohrinnendurchmesser
✓=Kombinationsmöglichkeit Armatur / Schlauch

NL=longueur nominale du tuyau selon plan coté
DN/D=diamètre intérieur du tube
✓=possibilité de combinaison raccord / tuyaux

NL=nominal length of tube as per drawing
DN/D=tube inside diameter
✓=possible combinations fitting / hose

Rohrstutzen 45°

mit SERTO-Armaturenanschluss

Embout lisse 45°

avec ecrou de raccord SERTO

Cylindrical stub 45°

with SERTO nut connection

JES-SO 45°

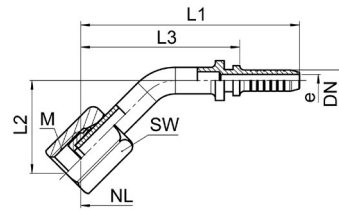

Type -DN -d -M	Mat.-Nr.	bar	SW	L1	L2	L3	e	kg/100	1AQ	1GQ	1HQ	1SQ	2SQ
JESSO 1/8 -6 -M10x1 45°	497.1145.115	200	12	49.5	20.0	36.0	2.0	1.390	✓	✓			
JESSO 3/16 -6 -M10x1 45°	497.1145.215	200	12	49.5	20.0	36.0	2.8	1.510	✓				✓
JESSO 1/4 -6 -M10x1 45°	497.1145.315	200	12	49.5	20.0	36.0	4.0	1.590				✓	✓
JESSO 1/4 -8 -M12x1 45°	497.1145.319	200	14	59.0	25.0	45.5	4.5	1.850				✓	✓
JESSO 3/8 -10 -M14x1 45°	497.1145.522	160	17	68.0	30.0	51.5	7.0	4.040				✓	✓
JESSO 3/8 -12 -M16x1 45°	497.1145.525	160	19	77.0	33.5	60.5	7.0	4.470				✓	✓
JESSO 1/2 -12 -M16x1 45°	497.1145.625	160	19	79.5	34.5	60.0	9.5	5.460				✓	✓
JESSO 1/2 -15 -M20x1.5 45°	497.1145.635	100	24	98.0	45.5	78.0	9.5	7.460				✓	✓

Bei Kombinationen Jacoflon-Schlauch mit JES-SO Armaturen gilt die jeweils schwächere Druckangabe.

Pour des combinaisons de tuyaux Jacoflon équipés de raccords JES-SO, il faut prendre en compte la pression la plus faible des composants.

For combinations Jacoflon tube with JES-SO unions, the lower pressure value applies.

Rohrstutzen 90°

mit SERTO-Armaturenanschluss

Embout lisse 90°

avec ecrou de raccord SERTO

Cylindrical stub 90°

with SERTO nut connection

JES-SO 90°

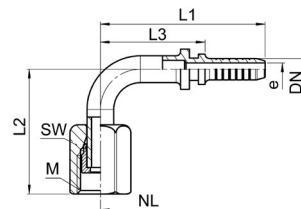

Type -DN -d -M	Mat.-Nr.	bar	SW	L1	L2	L3	e	kg/100	1AQ	1GQ	1HQ	1SQ	2SQ
JESSO 1/8 -6 -M10x1 90°	497.1195.115	200	12	37.0	29.0	23.5	2.0	1.390	✓	✓			
JESSO 3/16 -6 -M10x1 90°	497.1195.215	200	12	37.0	29.0	23.5	2.8	1.510	✓				✓
JESSO 1/4 -6 -M10x1 90°	497.1195.315	200	12	37.0	29.0	23.5	4.5	1.590				✓	✓
JESSO 1/4 -8 -M12x1 90°	497.1195.319	200	14	44.0	32.5	30.5	4.5	1.850				✓	✓
JESSO 3/8 -10 -M14x1 90°	497.1195.522	160	17	49.0	42.5	32.5	7.0	4.040				✓	✓
JESSO 3/8 -12 -M16x1 90°	497.1195.525	160	19	57.0	45.5	40.5	7.0	4.470				✓	✓
JESSO 1/2 -12 -M16x1 90°	497.1195.625	160	19	60.0	46.5	40.5	9.5	5.460				✓	✓
JESSO 1/2 -15 -M20x1.5 90°	497.1195.635	100	24	69.5	62.0	50.0	9.5	7.460				✓	✓

Bei Kombinationen Jacoflon-Schlauch mit JES-SO Armaturen gilt die jeweils schwächere Druckangabe.

Pour des combinaisons de tuyaux Jacoflon équipés de raccords JES-SO, il faut prendre en compte la pression la plus faible des composants.

For combinations Jacoflon tube with JES-SO unions, the lower pressure value applies.

NL=Nennlänge des Schlauches gemäß Massbild
DN/D=Rohrinnendurchmesser
✓=Kombinationsmöglichkeit Armatur / Schlauch

NL=longueur nominale du tuyau selon plan coté
DN/D=diamètre intérieur du tube
✓=possibilité de combinaison raccord / tuyaux

NL=nominal length of tube as per drawing
DN/D=tube inside diameter
✓=possible combinations fitting / hose

Stutzen

mit konischem Anschlussgewinde

Raccord

avec adaptateur mâle conique

Connector

with conical male adaptor

JES-R

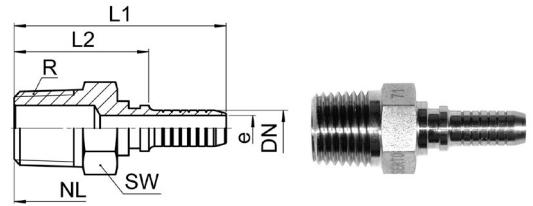

Type -DN -R	Mat.-Nr.	SW	L1	L2	e	kg/100	1 AQ	1 GQ	1 HQ	1 SQ	2 SQ
JESTA 1/8 -1/8	495.1605.110	10	32.0	18.5	2.0	1.260	✓	✓			
JESTA 3/16 -1/8	495.1605.210	10	32.0	18.5	3.0	1.310	✓				✓
JESTA 3/16 -1/4	495.1605.217	14	37.0	23.5	3.0	1.940	✓				✓
JESTA 1/4 -1/4	495.1605.317	14	37.0	23.5	4.5	2.320				✓	✓
JESTA 3/8 -3/8	495.1605.520	17	42.0	25.5	7.0	3.760				✓	✓
JESTA 1/2 -1/2	495.1605.630	22	48.0	28.5	9.5	6.570				✓	✓
JESTA 5/8 -3/4	495.1605.750	27	54.0	31.5	12.0	10.380					✓
JESTA 3/4 -3/4	495.2605.850	27	55.0	32.5	15.0	12.980					✓
JESTA 1 -1	495.2605.960	36	61.0	38.5	21.0	22.940					✓
JESTA 3/8 -3/8 HQ	495.8605.520	17	59.5	26.5	7.0	3.500			✓		
JESTA 1/2 -1/2 HQ	495.8605.630	22	69.5	31.5	9.5	6.900			✓		
JESTA 3/4 -3/4 HQ	495.8605.850	27	77.5	34.5	15.0	12.400			✓		
JESTA 1 -1 HQ	495.8605.960	36	87.0	40.5	20.0	25.200			✓		

Stutzen mit Universaldichtkegel 60°

mit Überwurfmutter

Raccord avec cône d'étanchéité 60°

avec ecrou

Connector with conical sealing nipple 60°

with union nut

JES-DK

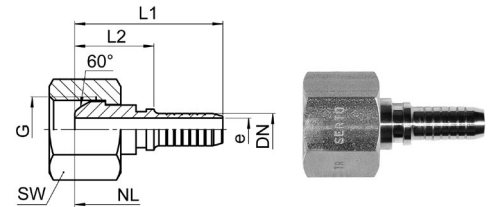

Type -DN -G	Mat.-Nr.	SW	L1	L2	e	kg/100	1 AQ	1 GQ	1 HQ	1 SQ	2 SQ
JESDK 60° -1/8 -1/8	497.1355.110	14	28.0	14.5	2.0	2.050	✓	✓			
JESDK 60° -3/16 -1/4	497.1355.217	17	29.0	15.5	3.0	3.010	✓				✓
JESDK 60° -1/4 -1/4	497.1355.317	17	29.0	15.5	4.5	3.030				✓	✓
JESDK 60° -3/8 -3/8	497.1355.520	19	33.0	16.5	7.0	3.780				✓	✓
JESDK 60° -1/2 -1/2	497.1355.630	24	38.0	18.5	9.5	6.720				✓	✓
JESDK 60° -5/8 -3/4	497.1355.750	32	39.0	16.5	12.0	11.970					✓
JESDK 60° -3/4 -3/4	497.2355.850	32	39.0	16.5	15.0	11.710					✓
JESDK 60° -1 -1	497.2355.960	41	40.0	17.5	21.0	21.260					✓
JESDK 60° -3/8 -3/8 HQ	497.8355.520	19	50.5	17.5	7.0	3.600			✓		
JESDK 60° -1/2 -1/2 HQ	497.8355.630	24	58.5	20.5	9.5	6.600			✓		
JESDK 60° -3/4 -3/4 HQ	497.8355.850	32	61.0	18.0	15.0	11.100			✓		
JESDK 60° -1 -1 HQ	497.8355.960	41	66.0	19.5	20.0	22.800			✓		

NL=Nennlänge des Schlauches gemäß Massbild
 DN/D=Rohrinnendurchmesser
 ✓=Kombinationsmöglichkeit Armatur / Schlauch

NL=longueur nominale du tuyau selon plan coté
 DN/D=diamètre intérieur du tube
 ✓=possibilité de combinaison raccord / tuyaux

NL=nominal length of tube as per drawing
 DN/D=tube inside diameter
 ✓=possible combinations fitting / hose

45° Stutzen mit Universaldichtkegel 60°

mit Überwurfmutter

Raccord 45° avec cône d'étanchéité 60°

avec ecrou

45° connector with conical sealing nipple 60°

with union nut

JES-DK 45°

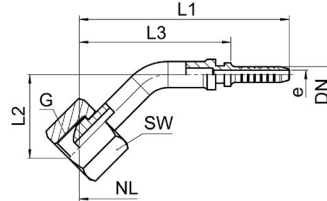

Type -DN -G	Mat.-Nr.	SW	L1	L2	L3	e	kg/100	1AQ	1GQ	1HQ	1SQ	2SQ
JESDK 60° -1/8 -1/8 45°	497.1345.110	14	48.5	19.5	35.0	2.0	1.900	✓	✓			
JESDK 60° -1/4 -1/4 45°	497.1345.317	17	54.5	23.5	41.0	4.0	3.350				✓	✓
JESDK 60° -3/8 -3/8 45°	497.1345.520	19	69.5	23.5	53.0	7.0	4.400				✓	✓
JESDK 60° -1/2 -1/2 45°	497.1345.630	24	92.0	31.0	72.5	9.0	10.300				✓	✓

90° Stutzen mit Universaldichtkegel 60°

mit Überwurfmutter

Raccord 90° avec cône d'étanchéité 60°

avec ecrou

90° connector with conical sealing nipple 60°

with union nut

JES-DK 90°

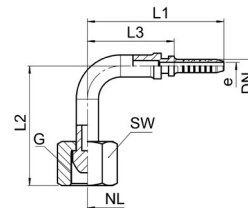

Type -DN -G	Mat.-Nr.	SW	L1	L2	L3	e	kg/100	1AQ	1GQ	1HQ	1SQ	2SQ
JESDK 60° -1/8 -1/8 90°	497.1395.110	14	33.0	30.5	19.5	2.0	1.900	✓	✓			
JESDK 60° -1/4 -1/4 90°	497.1395.317	17	38.5	35.0	25.0	4.0	3.350				✓	✓
JESDK 60° -3/8 -3/8 90°	497.1395.520	19	50.5	46.5	34.0	7.0	4.400				✓	✓
JESDK 60° -1/2 -1/2 90°	497.1395.630	24	66.0	49.0	46.5	9.0	10.300				✓	✓

NL=Nennlänge des Schlauches gemäß Massbild
 DN/D=Rohrinnendurchmesser
 ✓=Kombinationsmöglichkeit Armatur / Schlauch

NL=longueur nominale du tuyau selon plan coté
 DN/D=diamètre intérieur du tube
 ✓=possibilité de combinaison raccord / tuyaux

NL=nominal length of tube as per drawing
 DN/D=tube inside diameter
 ✓=possible combinations fitting / hose

Stutzen mit Dichtkegel 24° und O-Ring

mit Überwurfmutter

Raccord avec cône d'étanchéité 24° et joint torique

avec écrou

Connector with sealing cone 24° and O-ring

with union nut

JEDKOL

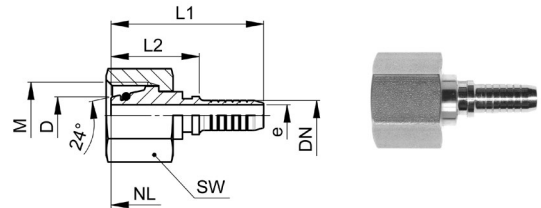

Type-DN-M	Mat.-Nr.	SW	L1	L2	L3	e	kg/100	1AQ	1GQ	1HQ	1SQ	2SQ
JEDKOL 24°-¼ -08L-M14x1.5	497.1405.319	17	32	18.5	4.5	7.7	2.4				✓	✓
JEDKOL 24°-⅜ -10L-M16x1.5	497.1405.522	19	36	19.5	6	9.7	3.6				✓	✓
JEDKOL 24°-½ -12L-M18x1.5	497.1405.625	22	41.5	22	9.5	11.7	5.1				✓	✓
JEDKOL 24°-½ -15L-M22x1.5	497.1405.635	27	39	19.5	9.5	14.7	6.7				✓	✓

45° Stutzen mit Dichtkegel 24° und O-Ring

mit Überwurfmutter

Raccord 45° avec cône d'étanchéité 24° et joint torique

avec écrou

45° connector with sealing cone 24° and O-ring

with union nut

JEDKOL 45°

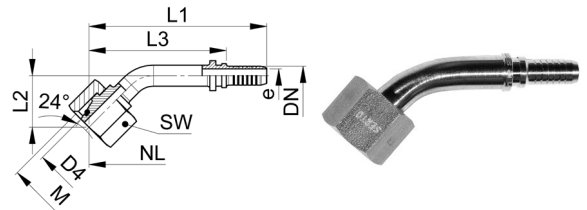

Type- DN-M	Mat.-Nr.	SW	L1	L2	L3	e	D4	kg/100	1AQ	1GQ	1HQ	1SQ	2SQ
JEDKOL 24°-¼ -08L-M14x1.5 45°	497.1445.319	17	59	17.2	46	4.5	7.8	3				✓	✓
JEDKOL 24°-⅜ -10L-M16x1.5 45°	497.1445.522	19	70	22	55	6	9.8	5.5				✓	✓
JEDKOL 24°-½ -12L-M18x1.5 45°	497.1445.625	22	94.5	26	75	8	11.8	9.8				✓	✓
JEDKOL 24°-½ -15L-M22x1.5 45°	497.1445.635	27	92	26	72.5	9	14.8	11.4				✓	✓

90° Stutzen mit Dichtkegel 24° und O-Ring

mit Überwurfmutter

Raccord 90° avec cône d'étanchéité 24° et joint torique

avec écrou

90° connector with sealing cone 24° and O-ring

with union nut

JEDKOL 90°

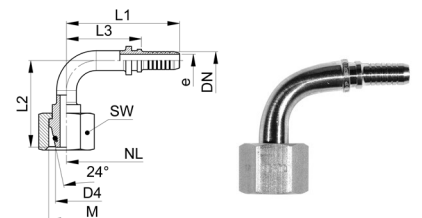

Type- DN-M	Mat.-Nr.	SW	L1	L2	L3	e	D4	kg/100	1AQ	1GQ	1HQ	1SQ	2SQ
JEDKOL 24°-¼ -08L-M14x1.5 90°	497.1495.319	17	40	30.5	26.5	4.5	7.8	3				✓	✓
JEDKOL 24°-⅜ -10L-M16x1.5 90°	497.1495.522	19	46.5	38	30	6	9.8	5.5				✓	✓
JEDKOL 24°-½ -12L-M18x1.5 90°	497.1495.625	22	64	49.5	44.5	8	11.8	9.8				✓	✓
JEDKOL 24°-½ -15L-M22x1.5 90°	497.1495.635	27	62	49	42.5	9	14.8	11.4				✓	✓

NL=Nennlänge des Schlauches gemäss Massbild
DN/D=Rohrinnendurchmesser
✓=Kombinationsmöglichkeit Armatur / Schlauch

NL=longueur nominale du tuyau selon plan coté
DN/D=diamètre intérieur du tube
✓=possibilité de combinaison raccord / tuyaux

NL=nominal length of tube as per drawing
DN/D=tube inside diameter
✓=possible combinations fitting / hose

Stutzen mit Planfläche mit PTFE-Dichtring

mit Überwurfmutter

Raccord avec surface plane avec joint en PTFE

avec ecrou

Connector with flat face end with PTFE gasket

with union nut

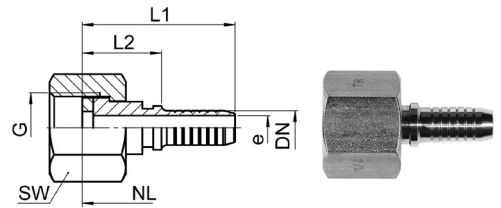

JES-PL

Type -DN -G	Mat.-Nr.	SW	L1	L2	e	kg/100	1 AQ	1 GQ	1 HQ	1 SQ	2 SQ
JESPL -1/8 -1/8	497.1365.110	14	26.5	13.0	2.0	1.980	✓	✓			
JESPL -3/16 -1/4	497.1365.217	17	28.0	14.5	3.0	2.910	✓				✓
JESPL -1/4 -1/4	497.1365.317	17	28.0	14.5	4.5	2.940				✓	✓
JESPL -3/8 -3/8	497.1365.520	19	31.0	14.5	7.0	3.590				✓	✓
JESPL -1/2 -1/2	497.1365.630	24	34.0	14.5	9.5	6.240				✓	✓
JESPL -5/8 -3/4	497.1365.750	32	36.0	13.5	12.0	11.110					✓
JESPL -3/4 -3/4	497.2365.850	32	37.0	14.5	15.0	11.320					✓
JESPL -1 -1	497.2365.960	41	38.0	15.5	21.0	20.620					✓
JESPL -1/2 -1/2 WELL	497.9365.630	24	48.0	17.0	10.0	9.060			✓		
JESPL -3/4 -3/4 WELL	497.9365.850	32	56.0	17.0	16.0	17.000			✓		
JESPL -1 -1 WELL	497.9365.960	41	64.0	17.5	20.0	30.270			✓		✓

45° Stutzen mit Planfläche mit PTFE-Dichtring

mit Überwurfmutter

Raccord 45° avec surface plane avec joint en PTFE

avec ecrou

45° connector with flat face end with PTFE gasket

with union nut

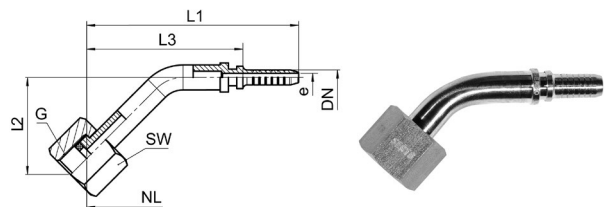

JES-PL 45°

Type -DN -G	Mat.-Nr.	SW	L1	L2	L3	e	kg/100	1 AQ	1 GQ	1 HQ	1 SQ	2 SQ
JESPL -1/8 -1/8 45°	497.1340.110	14	53.0	20.0	40.0	2.0	1.950	✓	✓			
JESPL -1/4 -1/4 45°	497.1340.317	17	54.5	23.0	41.0	4.0	3.250				✓	✓
JESPL -3/8 -3/8 45°	497.1340.520	19	68.0	25.0	52.0	7.0	4.100				✓	✓
JESPL -1/2 -1/2 45°	497.1340.630	24	90.0	31.5	70.5	9.0	6.800				✓	✓

NL=Nennlänge des Schlauches gemäss Massbild
DN/D=Rohrinnendurchmesser
✓=Kombinationsmöglichkeit Armatur / Schlauch

NL=longueur nominale du tuyau selon plan coté
DN/D=diamètre intérieur du tube
✓=possibilité de combinaison raccord / tuyaux

NL=nominal length of tube as per drawing
DN/D=tube inside diameter
✓=possible combinations fitting / hose

90° Stutzen mit Planfläche mit PTFE-Dichtring

mit Überwurfmutter

Raccord 90° avec surface plane avec joint torique en PTFE

avec écrou

90° connector with flat face end with PTFE gasket

with union nut

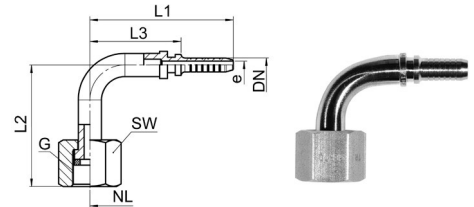

JES-PL 90°

Type -DN -G	Mat.-Nr.	SW	L1	L2	L3	e	kg/100	1 AQ	1 GQ	1 HQ	1 SQ	2 SQ
JESPL -1/8 -1/8 90°	497.1390.110	14	42.0	28.5	28.5	2.0	1.950	✓	✓			
JESPL -1/4 -1/4 90°	497.1390.317	17	38.5	34.0	25.0	4.0	3.250				✓	✓
JESPL -3/8 -3/8 90°	497.1390.520	19	50.5	34.5	34.0	7.0	4.100				✓	✓
JESPL -1/2 -1/2 90°	497.1390.630	24	67.0	46.5	47.5	9.0	6.800				✓	✓

Dichtscheibe PTFE

für Planfläche

Joint plat en PTFE

pour surface plane

PTFE gasket

for flat face end

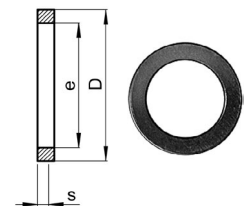

J-PTFE-SCHEIBE

Type	Mat.-Nr.	D	e	s	kg/100
J-PTFE-Scheibe: 1/8 8/5x1,5	496.1808.110	8.0	5.0	1.50	0.100
J-PTFE-Scheibe: 1/4 1 1/8x2	496.1808.317	11.0	6.0	2.00	0.100
J-PTFE-Scheibe: M14x1,5 12/7x2	496.1808.319	12.0	7.0	2.00	0.100
J-PTFE-Scheibe: 3/8 14/9x2	496.1808.520	14.0	9.0	2.00	0.100
J-PTFE-Scheibe: 1/2 16/10x2	496.1808.525	16.0	10.0	2.00	0.100
J-PTFE-Scheibe: 3/4 18/12x2	496.1808.630	18.0	12.0	2.00	0.100
J-PTFE-Scheibe: M22x1,5	496.1808.632	19.5	12.0	2.00	0.100
J-PTFE-Scheibe: 1 24/18x2	496.2808.850	24.0	18.0	2.00	0.100
J-PTFE-Scheibe: 1 30/20x2	496.2808.960	30.0	20.0	2.00	0.100

NL=Nennlänge des Schlauches gemäß Massbild
DN/D=Rohrinnendurchmesser
✓=Kombinationsmöglichkeit Armatur / Schlauch

NL=longueur nominale du tuyau selon plan coté
DN/D=diamètre intérieur du tube
✓=possibilité de combinaison raccord / tuyaux

NL=nominal length of tube as per drawing
DN/D=tube inside diameter
✓=possible combinations fitting / hose

Installation guidelines Jacoflon

Hose lines must be arranged so that they are easy to install and check; chafing on other components must be avoided. It is essential that the stated minimum bending radii are complied with. In case of frequent movement the size of the hose should be increased by up to 50 % in order to improve the lifespan of the hose. Each hose line must be installed so that it sags, taking into consideration any changes in length of the hose line under pressure. Torsional strain on the hose must be avoided during installation and in operation. Otherwise, axial swivel joints should be used. Ensure that the hoses are long enough, so that the hose line does not kink due to the movement of machine components.

Correct installation

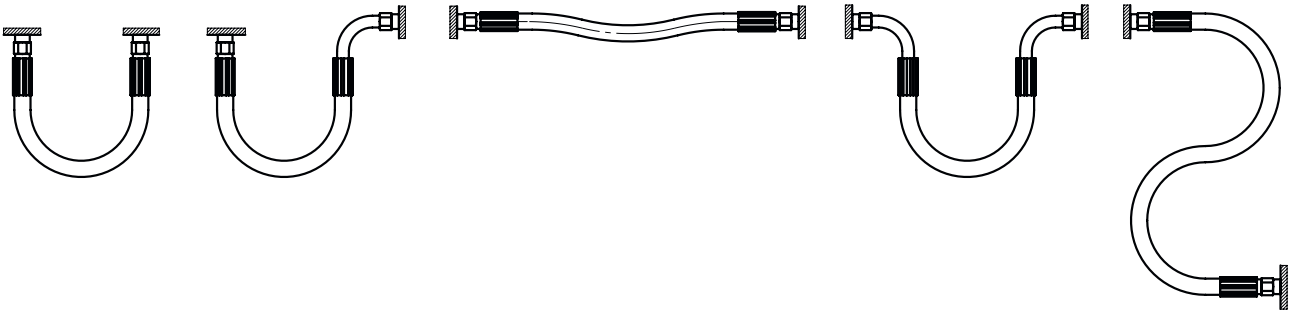

Incorrect installation

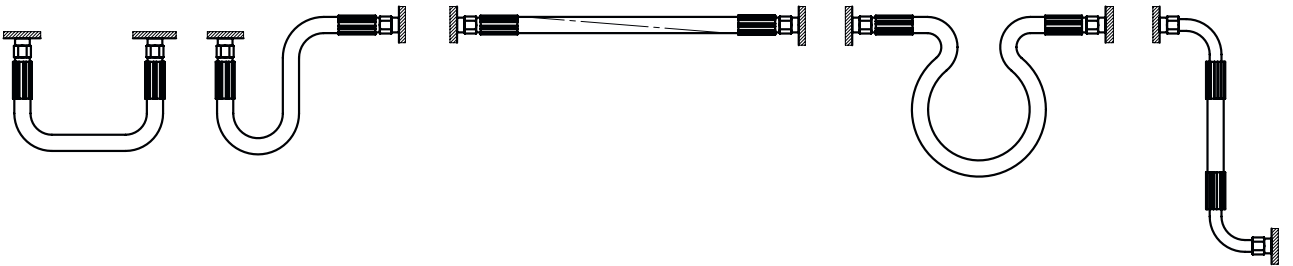

General information

Permeability of Jacoflon hoses

Permeability is the molecular transport of a gaseous medium through a physical, solid body by:

1. adsorption and absorption on the high concentration side,
2. diffusion through the solid material, e.g. hose material (PTFE core),
3. desorption from the low concentration side.

This very complex problem in combination with plastics is further negatively influenced by:

- the condition as delivered,
- the physical properties of the plastic,
- the chemical compositions of the medium and of the plastic used.

- High flexible quality HQ

Maximum flexibility is achieved by the extremely thin PTFE core. However, the thin core leads to a higher permeability and is therefore not ideal for gas applications.

Permeation concentration

The concentration difference between the medium and the surroundings is the driving force of permeation and not necessarily the nominal pressure of the medium in the hose.

The permeability of the hose increases exponentially with increasing temperature.

Jacoflon in vacuum applications

The smaller the inner diameter of the hose, the more suitable it is for use in vacuum applications. It is clear that we speak of rough vacuum to high vacuum. The vacuum is limited by the permeability of the hose and the collapse of the PTFE core.

Static applications

Given by the permeability, applications with gaseous media are recommended only if continuous supply and pressurisation are assured.

Example: A fire extinguisher line filled with CO₂ at 60 bar will, over time, lose pressure and eventually become completely depressurised.

Interpretation of the safety factor

The safety factor for Jacoflon hoses is determined for a sudden rise in pressure with water or hydraulic oil. No account is taken of the fall off in pressure but only of the failure of the hose/braid.

Rotation angle for angled fittings

If angled fittings are used on both sides, the rotation angle can be selected. This is defined, starting from the 1. fitting, in steps of 45° counterclockwise.

Examples:

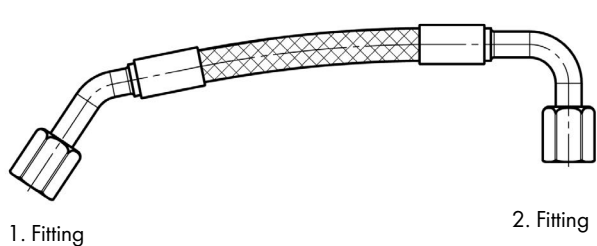

Rotation angle 0°

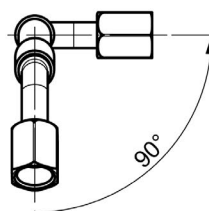
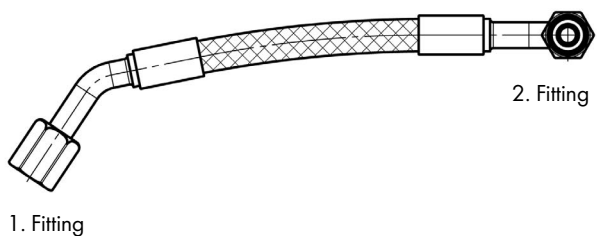

Rotation angle 90°

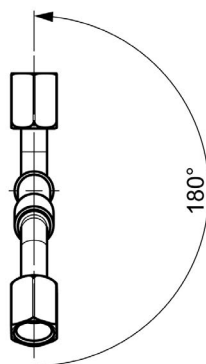
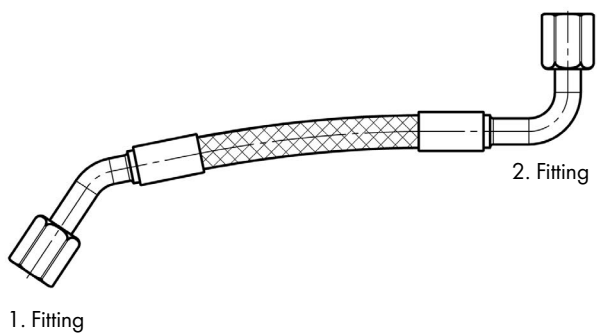

Rotation angle 180°

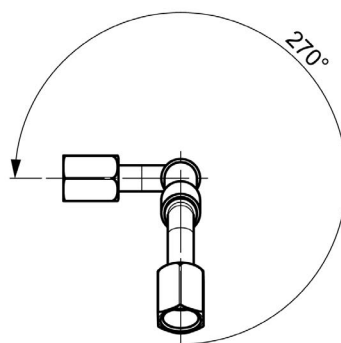
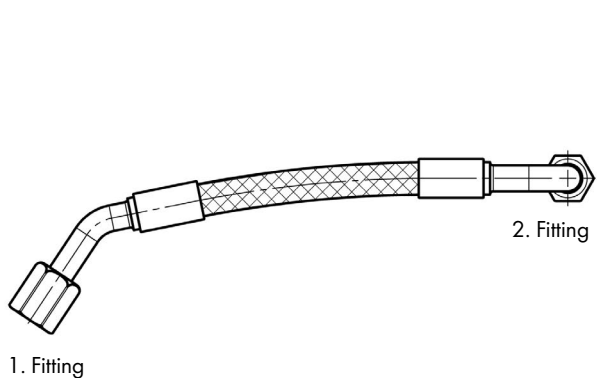

Rotation angle 270°

SERTO®



CH: SERTO AG, CH-8500 Frauenfeld, Tel. +41 (0)52 368 11 11, Fax +41 (0)52 368 11 12, info-ch@serto.com
D: SERTO GmbH, D-34123 Kassel, Tel. +49 (0)561 58004-0, Fax +49 (0)561 58004-44, info-de@serto.com
F: SERTO S.A.R.L., F-77164 Ferrières en Brie, Tél. +33 (0)1 64 30 38 38, Fax +33 (0)1 64 30 40 40, info-fr@serto.com
I: SERTO Italiana S.r.l., I-20099 Sesto S. Giovanni (Mi), Tel. +39 02 970 641 91, Fax +39 02 970 641 94, info-it@serto.com
www.serto.com

All data are for the purpose of providing technical information and do not constitute part of any warranty. Technical data and details subject to change. Please also refer to our general terms and conditions of sale.